

OPERATING MANUAL

FT-212RH



YAESU MUSEN CO., LTD.
C.P.O. BOX 1500
TOKYO, JAPAN

YAESU FT-212RH COMPACT 2m FM MOBILE TRANSCEIVER

The FT-212RH is a compact, full-featured frequency synthesized FM mobile/base transceiver providing selectable power output of 5 and 45 watts on the 2m amateur band. Unique features include the optional DVS-1 Digital Voice System, which provides local and remote digital voice recording and playback when installed in the FT-212RH.

Inside the FT-212RH, surface-mount components provide high reliability and performance, while modular circuit construction makes servicing easy. An all-new compartmentalized die-cast chassis provides superb rf isolation and incredible overall ruggedness. A large liquid crystal display includes a bargraph PO/S-meter. Ambient light is sensed to automatically control the brightness of the display back-lighting and pilot lamps, dimming the display in dark environments.

Operating features include memory selection and tuning in 5, 10, 12.5, 20 and 25 kHz selectable steps; The channel memory system includes eighteen general purpose memories, a one-touch recall CALL channel memory and two subband limit memories (for programmable subband scanning); one-touch repeater reverse; band and selected memory scanning with auto-resume after carrier-drop or 5-second pause, and priority channel monitoring. Memory hiding and scan-skip are easily settable.

Nineteen of the memories store either programmable repeater shift or independent transmit and receive frequencies. Automatic Repeater Shift (ARS) can be enabled to select repeater transmitter offset automatically when tuned to a standard repeater subband. Any of 37 standard CTCSS (subaudible) tone frequencies (plus 97.4 Hz) can be displayed, selected and programmed into any memory channel for transmission, and when the optional FTS-12 Unit is installed, for silent monitoring.

The microphone jack includes signals for CAT System control from an external personal computer, and memory cloning to/from other FT-212RHs. A 1750 Hz burst tone generator is built-in and can be activated from the MH-14A8 Speaker/Mic. DTMF keypad microphone options include the MH-15C8 and the MH-15D8 with its own auto-dial DTMF memories. If

the burst tone is not needed, an internal jumper can be set to allow packet radio tnc interfacing via the microphone jack.

Along with one microphone, the MMB-37 Reversible Mobile Bracket is supplied with the transceiver. For base station installations, the FP-700 AC Power Supply/External Speaker is optionally available.

Please read this manual before installing or operating the FT-212RH.

SUPPLIED ACCESSORIES

MMB-37 Mobile Mounting Bracket D6000056
Power Supply Cable T9015615 with two 15A fuses, 2.8m
One of the microphones listed below.

OPTIONS

<u>Model</u>		<u>Order Code</u>
DVS-1	Digital Voice Memory Unit	D3000567
FTS-12	Tone Squelch Unit	D3000488
SP-55	External Speaker	
MH-14A8	Hand Speaker/Mic w/Burst Button	D1000051
MH-14B8	Hand Speaker/Mic	D1000052
MH-14D8	Standard Hand Mic	D1000067
MH-15C8	Hand Speaker/Mic w/DTMF keypad	D1000060
MH-15D8	Hand Mic w/DTMF Autodialler Memory	D1000061
MF-1A3B	Boom Microphone with flexible arm	
YH-1	Headset (w/microphone)	
SB-10	PTT Switch Unit for MF-1A3B or YH-1	

GENERAL

Frequency range:

Vers. A: 144-148 MHz

Vers. B: 144-146 MHz

Channel steps (user-selectable):

5/10/12.5/20/25 kHz

Standard repeater shift:

±600 kHz

Mode of emission:

G3E

Antenna impedance:

50 ohms, unbalanced

Supply voltage:

13.8 VDC ±10%, neg. ground

Supply current:

Transmit 45W: 10A

Receive 500mA; Stby 300mA

Operating temp. range:

-20 to +60 °C

Frequency accuracy:

±10ppm (-20° to +60°C)

Case size (WHD):

140 x 40 x 160mm

Weight:

Approx. 1.25 kg

RECEIVER

Circuit type:

Double-conversion superhet

Intermediate frequencies:

10.7 MHz & 455 kHz

Sensitivity (for 12dB SINAD):

better than 0.25µV

Image ratio:

better than 65dB

Selectivity (-6/-60dB):

12/30 kHz

Audio Output (for 5% THD):

at least 1.5W into 8 ohms

TRANSMITTER

RF output power (50 ohms):

5 watts and 45 watts

Modulation method:

Variable reactance

Maximum deviation:

±5 kHz

Spurious emissions:

at least 60 dB below carrier

Microphone impedance:

2 kilohms

Specifications subject to change without notice.

CONTROLS & CONNECTORS

FRONT PANEL

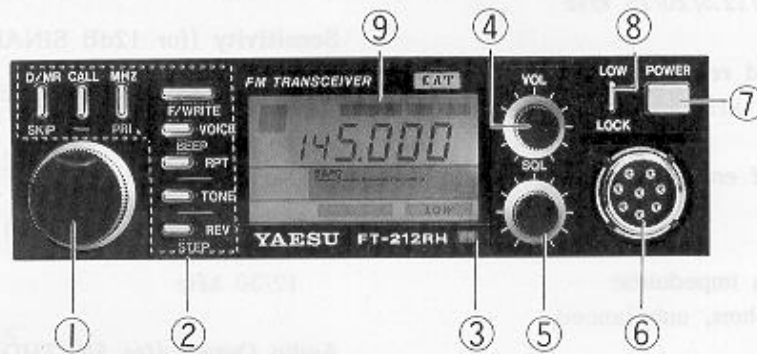

(1) Selector Knob

This 24-position detented rotary switch is used for tuning as well as a wide variety of function selections. The DWN and UP keys on the microphone duplicate the functions of this knob.

(2) Push Button Switches

These push buttons select the various operating features. One or more beeps will sound if the resulting command is accepted (beep notes are shown on page 33). The white labels above or to the right of the buttons indicate their primary functions, while the blue labels below the buttons indicate alternate functions, activated by pressing the F/WRITE button momentarily first, and then the other button within five seconds.

For descriptive purposes in this manual, alternate button functions are referenced by the blue label, with "[F] +" in front of it to remind you to press F/WRITE first. For example, "[F]+BEEP" indicates that you should press the F/WRITE button followed by the VOICE/BEEP button (within five seconds). All button functions are described in detail in the "Operation" section, and summarized in the Operator's Quick Reference Charts.

(3) Auto Dimmer Sensor

Behind the glass is a photosensor which detects the level of ambient light, causing the display lamps to be automatically dimmed in the dark.

(4) VOL Control

This control adjust the volume of the receiver audio.

(5) SQL Control

This control sets the threshold level at which received signals (or noise) open the squelch. For maximum squelch sensitivity set this control from counterclockwise just to the point where noise is silenced (and the BUSY indicator on the display is off) when the channel is clear.



(6) MIC Jack

This 8-pin jack accepts microphone input and scanning control from the microphone and/or control signals from an external computer. Memory cloning can be performed with another transceiver through this jack, and an internal modification also allows packet radio tnc connection here. Pinout is shown on the next page.

(7) POWER Switch

This two-position push button turns the transceiver on and off.

(8) LOW/LOCK Button

Normally, this button toggles between high and low transmitter power output. When low power is selected, two low-pitched beeps sound (), and "LOW" appears at the lower right corner of the display. Two high-pitched beeps sound () when high power is selected.

If the F/WRITE button is pressed just before pressing the LOW/LOCK button, transmitter power is not changed, but rather low/high beeps sound (), and "LOCK" appears in reverse letters at the lower left corner of the display, indicating that the selector knob and all other

buttons are now disabled. Pressing [F]+LOCK again sounds high/low beeps () as the lock condition is released.

(9) Display

The display segments are follows. The meaning of each is described elsewhere in this manual.

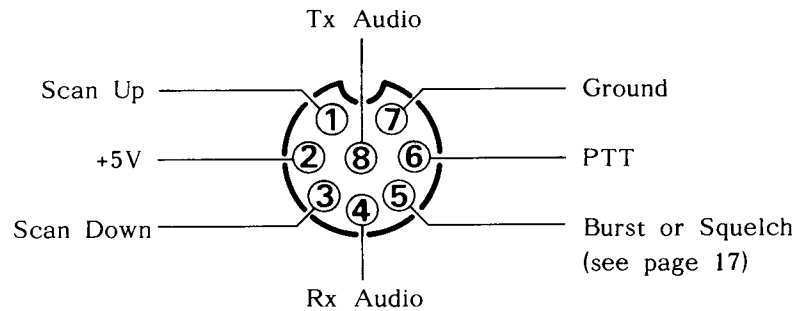
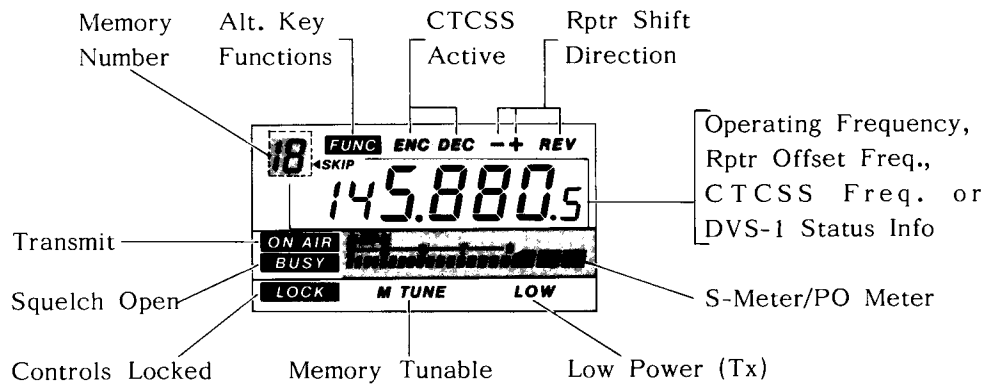

MIC Jack Pinout

REAR PANEL

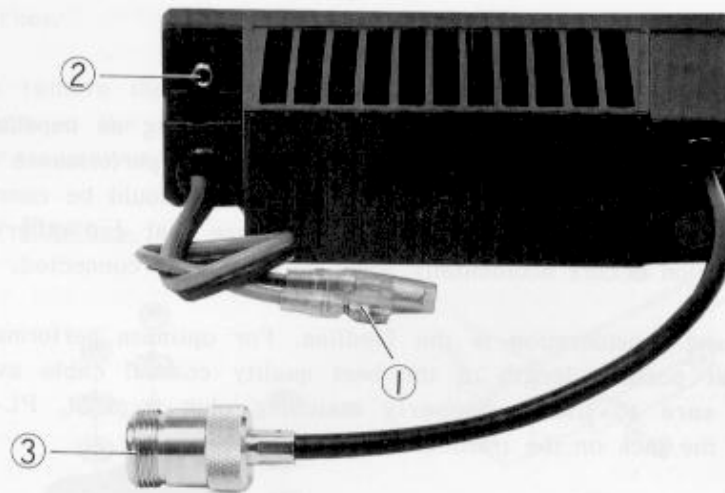

(1) 13.8VDC Cable Pigtail

This is the power supply connection for the transceiver. Use the fused DC Cable supplied with the transceiver to make connection between this pigtail and the car battery or other DC power supply capable of at least 10 Amperes (continuous). Make certain that the red lead connects to the positive side of the supply.

(2) EXT SP (External Speaker) Jack

This 2-contact mini phone jack accepts a 4- to 16-ohm external speaker such as the Yaesu SP-3, SP-4 or SP-55. When a plug is inserted into this jack the internal speaker is disabled.

(3) ANT (Antenna) Jack

Connect a 2m-band antenna to this type-M socket using 50-ohm coaxial cable and a type-M plug. Make sure the antenna is designed specifically for use at the operating frequency.

INSTALLATION

Antenna Considerations

The FT-212RH is designed for use with an antenna having an impedance near 50 ohms at the operating frequency. For optimum performance use a high-quality, carefully designed antenna. The antenna should be connected at all times when power is on, to avoid damage that can otherwise result if transmission occurs accidentally when no antenna is connected.

Another important consideration is the feedline. For optimum performance use the shortest possible length of the best quality coaxial cable available, and be sure to use a properly matching plug (type-M, PL-259 compatible) for the jack on the transceiver.

Mobile Installation

The FT-212RH must only be installed in cars having a negative ground electrical system. The transceiver should be located where the display, controls and microphone are easily accessible, and should be securely affixed using the supplied MMB-37 mobile mounting bracket. The transceiver may be installed in any position without adversely affecting its performance, but it should not be mounted near a heater vent or where it could interfere with safe operation of the vehicle. Make sure that plenty of space is provided at the rear of the transceiver so that air can flow freely around the heatsink. Refer to the diagrams on the facing page for installation of the MMB-37.

- (1) Using the mounting bracket as a template, locate the mounting holes after determining the mounting location with sufficient clearance for the transceiver. Use a 4.8mm (3/16") bit to drill the holes. Secure the bracket with the supplied screws, washers and nuts (Figure 1).
- (2) Screw the two mounting clips to the sides of the transceiver using the small hex bolts and washers supplied (Figure 2).

To install the transceiver, position the transceiver in the bracket so that the clip on the left side fits into the slot in the left side of the bracket (Figure 3), then push the right side of the transceiver upwards until it latches.

To remove the transceiver place your hand underneath it and pull the latch on the right side of the bracket outward until the right side of the transceiver drops free.

Figure 1.

Figure 2.

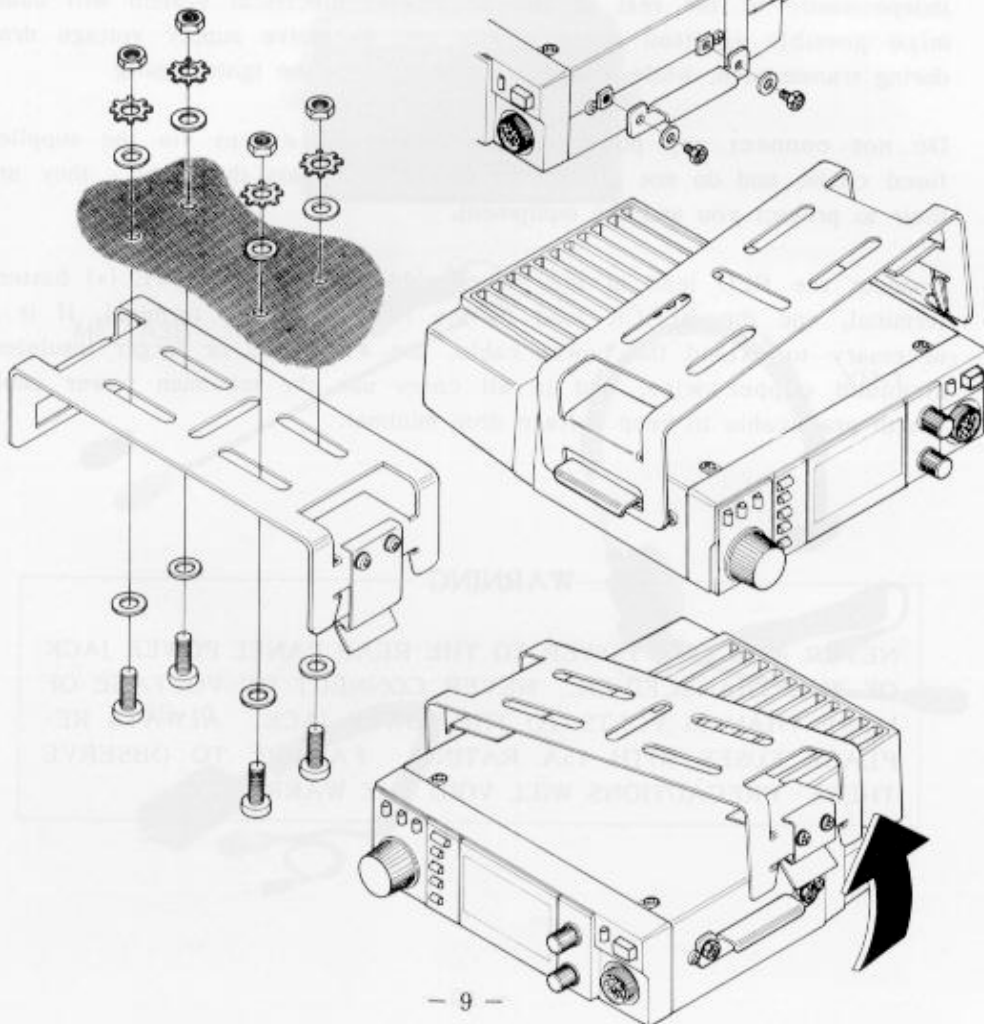

Mobile Power Connections

Before connecting the power cable the maximum battery charging voltage should be checked to ensure that it remains below 15V when the engine is run fast. If more than 15V, the voltage regulator of the car should be adjusted before connecting the transceiver.

Power connections should be made directly to the automobile battery using the supplied cable with 15A in-line fuses. Connection to the cigarette lighter or other accessory circuit may cause the fuse to blow in that circuit. Connecting the supplied DC power cable to the battery independently of the rest of the automobile electrical system will minimize possible ignition noise pickup and excessive supply voltage drop during transmission, while allowing operation with the ignition off.

Do not connect any power to the transceiver except via the supplied fused cable, and do not attempt to defeat or bypass the fuses - they are their to protect you and the equipment.

Connect the RED lead of the power cable to the POSITIVE (+) battery terminal, and the BLACK lead to the NEGATIVE (-) terminal. If it is necessary to extend the power cable, use #14 AWG or larger insulated, stranded copper wire, and in all cases use the minimum power cable length practicable to keep voltage drop minimal.

WARNING

NEVER APPLY AC POWER TO THE REAR PANEL POWER JACK OF THE TRANSCEIVER. NEVER CONNECT DC VOLTAGE OF MORE THAN 15 VOLTS TO THE POWER JACK. ALWAYS REPLACE FUSES WITH 15A RATING. FAILURE TO OBSERVE THESE PRECAUTIONS WILL VOID THE WARRANTY.

External Accessories

The SP-3, SP-4 and SP-55 External Speakers are optional accessories which allow the source of audio from the transceiver to be repositioned for optimum hearing. Especially practical for the noisy mobile environment, each includes its own swivel-type mounting bracket, and is available from your Yaesu dealer. Also available to enhance safety and mobile operating convenience are the YH-1 Headset with miniature boom microphone, and the full size MF-1A3B boom microphone with flexible arm (both of which use the SB-10 PTT switch).

SP-55



MF-1A3B



YH-1



SB-10



Base Station Installation

A power supply capable of providing at least 10A continuously at 13.8VDC is required for operation from the AC line, and an external speaker is recommended. The FP-700 AC power supply is available from your Yaesu dealer for this purpose. Use the fused DC power cable supplied with the transceiver for making power connections, and connect the external speaker to the EXT SP jack on the rear panel.

Packet Radio TNC Interconnections

Most popular packet radio tncs can be connected to the MIC jack of the FT-212RH as follows:

TNC Jack to Radio	FT-212RH MIC Jack
Receiver Audio in	pin 4 (8 ohms, de-emphasized)
Squelch Status in	pin 5* (open=5V, closed=0V 1 mA)
PTT (gnd=tx) out	pin 6
Transmit Audio out	pin 8 (400 ohms, pre-emphasized)

Use shielded cable for the audio lines, and keep the interconnecting cable as short as possible to avoid RF pickup.

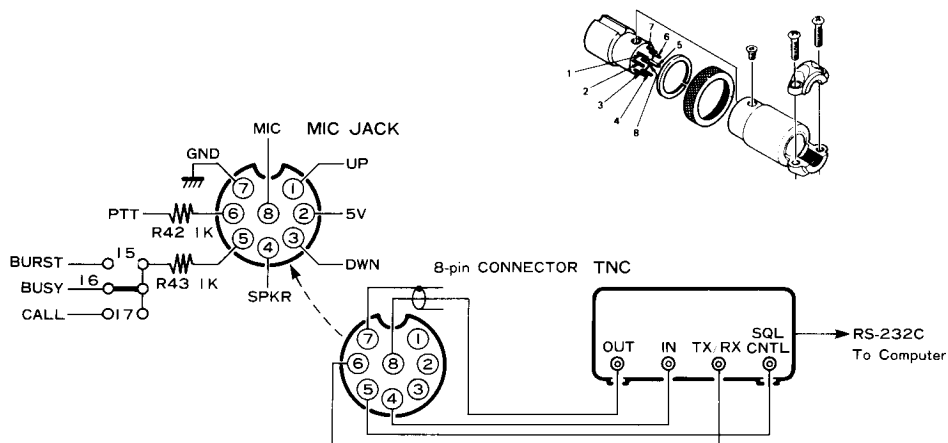

* Requires modification as described on page 17.

DVS-1 Digital Voice System Installation

The DVS-1 is a digital voice recording and playback system which allows you to record either through the microphone or the receiver, and to play back selected recorded messages through the speaker or transmitter. Remote-controlled recording and playback is also provided by a built-in DTMF decoder. See the special section at the end of this manual for complete details.

- (1) Disconnect the power cable at the rear of the transceiver, place the transceiver upside-down on the workbench, and remove the four screws on the bottom cover. Loosen the two screws on each side, and then remove the bottom cover (Figure 1).
- (2) Lift the loudspeaker out of its holder, and then remove the three screws in the arms of the holder, and lift it out of the chassis (Figure 2).



Figure 1.

Figure 2.

Figure 3.

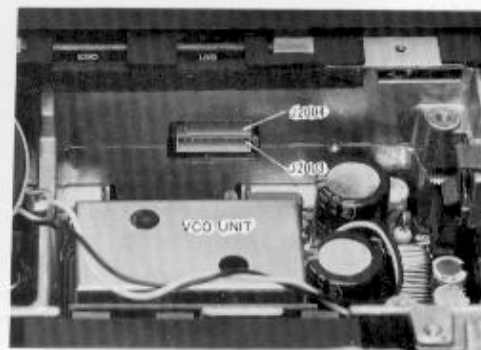
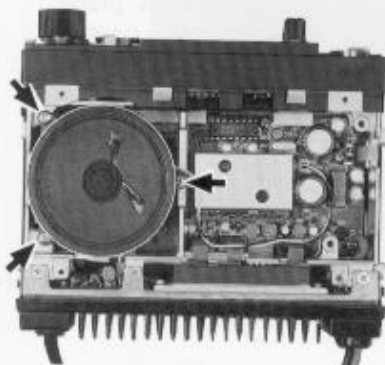

DVS-1
Backup Sw.

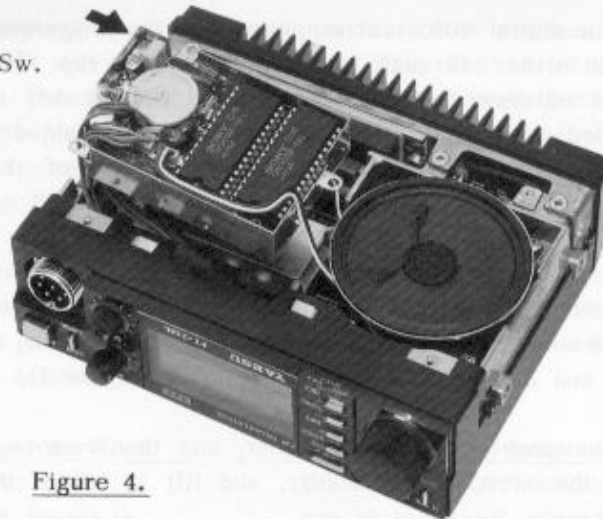

Figure 4.

- (3) Connect the 8-pin plug from the DVS-1 to 8-pin jack J2003 on the inside of the front panel (the gray wire should be nearest the center). See Figure 3.
- (4) Connect the 7-pin plug from the DVS-1 to 7-pin jack J2004 on the inside of the front panel (the brown wire should be nearest the center).
- (5) Connect the 3-pin plug from the DVS-1 to jack J1003 in the right front corner of the speaker compartment.
- (6) Making sure that no wires are pinched, set the DVS-1 in place, routing the speaker wires out under the back of the DVS-1. Install the two supplied screws through the tabs in the DVS-1: one in the left front corner of the chassis, and one in the rear.
- (7) Set the Voice Memory Backup switch in the left rear corner of the DVS-1 (Figure 4) to the ON position (toward the rear).
- (8) If also installing the FTS-12, proceed to step 2 of the FTS-12 Installation. Otherwise, do step 5 of the FTS-12 Installation.

FTS-12 Tone Squelch Unit Installation

The FTS-12 includes a decoder for 37 EIA standard subaudible CTCSS tones, programmable from the front panel of the FT-212RH. Silent monitoring of busy channels is provided when the FTS-12 is combined with the built-in CTCSS encoder functions and activated by the ENCode/DECode Tone Squelch function. The FTS-12 is available from your Yaesu dealer. See the "Operation" section for functional details.

- (1) Perform steps 1 and 2 of the DVS-1 Installation Procedure.
- (2) Remove the jumper plug from jack J1004 in the front left corner of the speaker compartment (Fig. 5).
- (3) Locate the unconnected brown 10-pin connector at the front of the speaker compartment. Align the small tab on one side of this connector with the hole in one side of the jack on the FTS-12, and mate these connectors (Fig. 6).
- (4) Press the FTS-12 into the clip on the speaker holder (Fig. 7). The output tone level (VR1 on the FTS-12) is adjusted at the factory for the proper deviation, so no adjustment is needed.
- (5) Replace the speaker holder and its three screws, and replace the speaker in the holder. Then replace the bottom cover and its four screws, and retighten the two screws on each side.

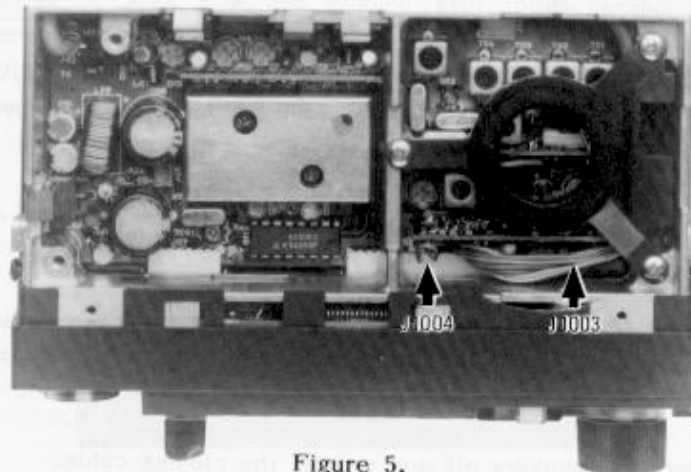

Figure 5.

Figure 6.

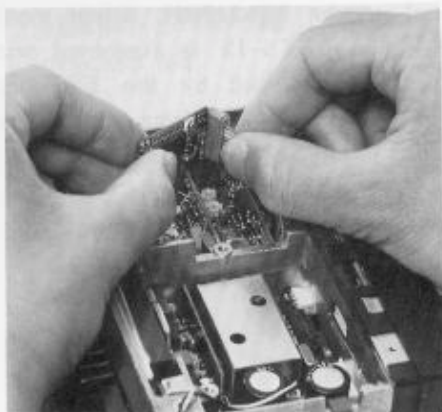
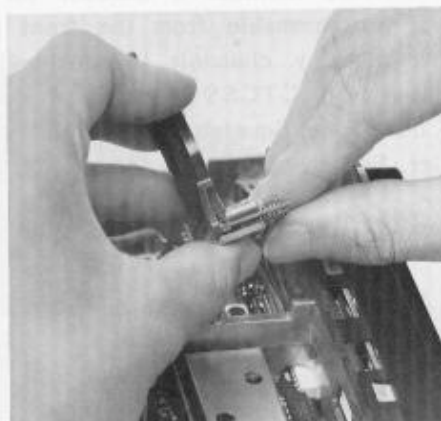
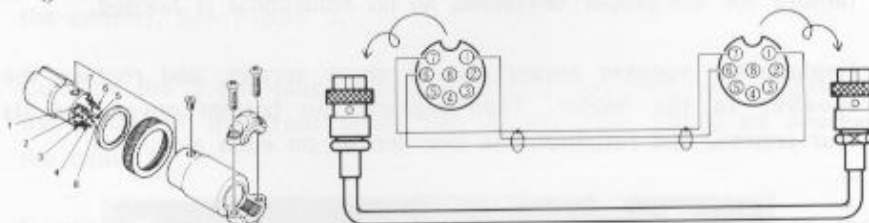

Figure 7.



Memory Cloning

All memory data stored in one transceiver can be moved to another by connecting the MIC jacks together as indicated in the diagram below (cloning cable is NOT available from Yaesu).



- (1) Turn both transceivers off, and then press and hold the F/WRITE buttons while turning the power switches on. The displays will be blinking.
- (2) Press the REV button on the destination transceiver (the display will stop blinking).
- (3) Press the RPT button on the source transceiver. When the data transfer is complete, the displays should return to normal. If "Err" is displayed, turn both transceivers off and try again.
- (4) Turn both transceivers off and remove the cloning cable.

Modification for Packet Radio

As supplied from the factory, pin 5 of the MIC jack is wired through solder bridge jumper no. 15 on the Control Unit to allow tone burst activation via the BURST button on the MH-14A8 microphone. For packet radio operation jumper 15 must be removed, disabling BURST control, and jumper 16 installed to provide output of the squelch BUSY line for packet radio tncs.

- (1) Remove the eight screws affixing the top and bottom covers, and the two screws on each side. Remove the covers.
- (2) Remove the ring nut and lockwasher around the MIC jack, and pull the three knobs from the front panel.
- (3) Without unclipping the plastic cover, grasp the front panel on the top and bottom edges, and carefully slide it forward just enough to expose the corner of the Control Unit pcb nearest the MIC jack.
- (4) Using a fine-tipped soldering iron and solder wick or a solder sucker, remove the solder bridge from BURST jumper pad 15, and then add solder to bridge BUSY pad 16.
- (5) Press the front panel assembly gently back into place (so that the holes in each side are aligned with those in the chassis). Replace the ring nut and washer over the MIC jack, and the knobs. Replace the top and bottom covers and their eight screws, and the four screws in the sides.

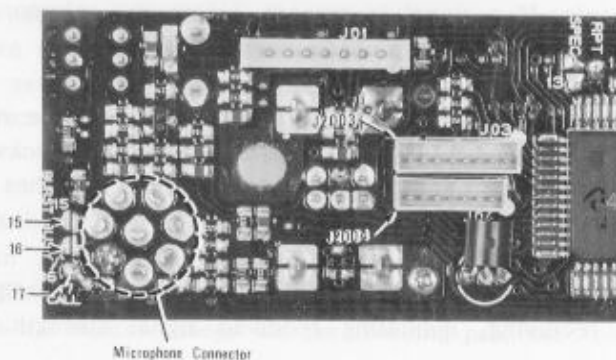

Microphone Connector

OPERATION

This chapter describes the various transceiver functions in detail. After studying these descriptions, keep the FT-212RH Operator's Quick Reference Charts handy in case you need to refresh your memory.

Preliminary Operating Information

Before operating the transceiver, recheck power supply and antenna connections. Never operate the transceiver without an antenna. Also, please read the chapter on Controls & Connectors, if you have not already, to familiarize yourself with the functions of the controls. Note especially the description on page 4 of the terminology used in this chapter when referring to the buttons.

When the buttons are pressed during reception, one or more beeps will sound if the command is accepted. Except for certain special cases mentioned later, the buttons are disabled during transmission.

If you have trouble getting the transceiver to work as described, see 'In Case of Problems' on page 40.

Squelch Setup



Before turning on the transceiver for the first time, set the VOL and SQL controls fully counterclockwise. Now press the POWER button and adjust the VOL control for a comfortable volume on the noise or received signal. "BUSY" should be displayed in reverse letters to the left of the S&PO meter scale. If a signal is present, rotate the selector knob until a frequency is found where only noise is heard.

Turn the SQL knob clockwise just to the point where the noise is silenced and "BUSY" disappears (if the SQL is set further clockwise, sensitivity to weak signals is reduced). Whenever a signal reaches the receiver that is strong enough to open the squelch, "BUSY" will be displayed.



Bargraph segments appear in the S&PO box below the frequency on the display while receiving, indicating received signal strength. This indica-

tion is not affected by the squelch setting, so even squelched signals will have some indication. If you notice more than one or two bargraph segments appearing while the squelch is still closed, try reducing the squelch control setting (if you want to hear weak signals).

Frequency & Step Selection

To select the MHz range in which you wish to operate, press the MHz button (if nothing happens, see the LOCK description on page 5). Digits to the right of the 1-MHz digit are cleared from the display for five seconds, during which you can use the selector knob or the microphone UP/DWN keys to change the MHz range. Try this, and note the beeps when using the microphone keys: () when moving up, and () when moving down. When done, press MHz again, or wait five seconds.

To tune your operating frequency, the transceiver must be in what we call the Dial mode (as opposed to the Memory mode, described later). If no Memory number is present in the shaded box in the upper left-hand corner of the display, the Dial mode is selected. Otherwise, press the D/MR button to change to the Dial mode.

You can use the selector knob or the microphone UP () and DWN () keys to select your operating frequency. However, if you press and hold the UP or DWN key for more than ½-second scanning will start. This is described later, so for now, just press the microphone key again to stop (if you have to).

Tuning steps are factory preset to 5 kHz (vers. A) or 25 kHz (vers. B). To change to another step size (5, 10, 12.5, 20 or 25 kHz) press [F]+REV and use the selector knob or microphone keys to select a different step (the step size is displayed at the right). The small "5" or "P" at the left is the scan mode indicator, described later. Once the desired step size is displayed, press REV to return to the operating frequency display.

DISABLING THE BEEPER

You can toggle the musical beeper on and off by pressing [F]+BEEP. While learning the features, we recommend you keep it on, as the musical beeps aid the learning process.

Transmitting

Press the LOW button to select low power output (). When you wish to transmit, wait until the channel is clear ("BUSY" not displayed), and squeeze the PTT switch on the microphone. During transmission "ON AIR" is displayed in reverse letters to the left of the S&PO box, and the bargraph shows relative transmitter power output. Release the PTT switch to receive.

If more power is required, press the LOW button again (). However, whenever communication is possible with low power, keep the LOW button depressed to minimize possible interference to other stations.

If using a version B (in Europe), press the BURST button on the MH-14A8 microphone, to transmit a 1750 Hz Burst Tone to access repeaters that require it.

Repeater Splits

The ARS (Automatic Repeater Shift) feature in the FT-212RH provides repeater shift of the transmit frequency whenever you are tuned to a standard repeater subband (see diagram below). When enabled, a small "-" or "+" displayed above the frequency indicates that repeater shift is active, and closing the push-to-talk switch changes the display to the (shifted) transmit frequency.

AUTOMATIC REPEATER SPLIT SUBBANDS

144.0								145.6	145.8	146.0	
Simplex								Minus	Simpex	Vers. B	
144.0	145.1	145.5	146.0	146.4	146.6	147.0	147.4	147.6	148.0		
Simplex	Minus	Simp	Plus	Simp	Minus	Plus	Simp	Minus	Vers. A		

The ARS function is disabled at the factory. To enable it, press F+[RPT] F+[RPT] (that is, each key, twice). Pressing F+[RPT] the first time displays the repeater shift offset (default 600 kHz, but adjustable) at the right, and if ARS is enabled, an "A" at the left. With this display, pres-

sing only the F/WRITE key toggles ARS between enabled and disabled states, and RPT returns the display to the operating frequency. So after pressing F+[RPT] the first time, if you want to leave ARS as it is, just press RPT. Otherwise, press F/WRITE to change it, and use the tuning knob or microphone keys to change the shift offset, finally pressing RPT when finished.

When the ARS feature is inactive (either disabled, or outside of the standard repeater subbands) the RPT button manually activates offset of the transmitting frequency from the receiving frequency for plus or minus shift. Just press RPT: once for minus shift, or twice for plus shift ("- " or "+ " displayed above the 10 kHz frequency digit). When you press the PTT switch to transmit (or the REV button to reverse transmit and receive frequencies), the display will shift down or up by the programmed offset, if in band (or else 'Err' is displayed). Pressing RPT again returns you to simplex operation.

As mentioned above, 600 kHz repeater offset is programmed in the transceiver, and can be easily reprogrammed as desired. If you have one or two repeaters in your area with non-standard splits, you can program separate transmit and receive frequencies in memory as described later. However, if most or all of the repeaters you want to work have a different offset than 600 kHz, you can reprogram the standard offset (as used by the RPT button and ARS) instead.

Memory Storage

The FT-212RH offers eighteen general purpose memories, numbered 1 through 18, and three special memories, labelled C, L and U. The general purpose memories and the "C" (Call Channel memory) can each store separate receive and transmit frequencies or repeater shift, and tone squelch data (if the optional FTS-12 is installed). The L and U memories can store everything except separate transmit frequencies, and are used for PMS operation, described later.

To store a frequency in memory:

- (1) Select the desired frequency (and repeater split, if desired) in the Dial mode as described above.

- (2) Press and hold the F/WRITE key for $\frac{1}{2}$ -second (until the second beep sounds). A Memory number appears blinking in the shaded box at the upper left corner of the display.
- (3) Within five seconds of step (2), use the selector knob or microphone UP/DWN keys to select the desired Memory for storage. If you select one that was already being used, it will be overwritten with new data in the next step.
- (4) Press F/WRITE again to store the displayed data into the selected Memory: the Memory number will stop blinking for a second, and then disappear as operation continues in the Dial mode.

When storing split-frequency memories you have the choice of either the Repeater Split method, described previously, or of storing separate transmit and receive frequencies. To store a separate transmit frequency, just store the receive frequency as described above, and then tune to the desired transmit frequency, press F/WRITE again for $\frac{1}{2}$ -second, and then hold the PTT switch while pressing F/WRITE once more (the transmitter is not activated in this case). By either method the results will be the same in operation, except that storing a separate transmit frequency applies only to one memory, while the offset method applies to all (when the RPT button is pressed).

Memory Recall

To recall stored memories press D/MR to select the Memory mode (Memory number is displayed), and then rotate the selector knob or press the up/down keys to select the desired memory. Only prestored memories are displayed: empty memories are skipped.

If you stored a memory for split-frequency operation by the offset method, "-" or "+" will be displayed to remind you of the shift. If you stored a memory with a separate transmit frequency, "-+" are displayed together to remind you of this. In either case, you can press the REV button to check the transmit frequency without actually transmitting (and press it again to return).

You can also retune a memory once it is recalled, by pressing the MHz button: "M TUNE" appears at the bottom center of the display, and you can tune the displayed memory frequency in the same ways as described before (including the "MHz" tuning). If you retune and want to store the new memory settings (in the current, or another memory), just follow steps (2) - (4) of the memory storage procedure above: operation will be left on the memory.

If you don't want to save your changes to the memory, just press D/MR: once to return to the original memory data, and again to leave the memories and return to the Dial mode.

Hiding and Erasing Memories

As already mentioned, storing data in a memory automatically overwrites data that was previously stored there. However, if you regularly move from one area to another, you may not want to use the same number of memories all the time, or you may wish to change your operating memories without having to rewrite them from scratch. This can be done by masking certain memories so that they are completely hidden from operation, and recalling them only when desired for operation.

To completely mask a memory, recall it and press F/WRITE for $\frac{1}{2}$ -second (until the memory number blinks). Then press the REV/STEP button. This causes the display to change to memory 1, and the previously-selected memory is no longer selectable manually, or by scanning (as described later).

To unmask a hidden memory for operation, recall any memory and press F/WRITE for $\frac{1}{2}$ -second. Then select the memory number to be restored, and press REV/STEP.

When you have hidden memories, avoid accidentally overwriting them.

Call Channel Memory

The call channel memory can be instantly recalled by pressing the CALL button. "C" appears in the memory window at the upper left corner of the display.

As mentioned earlier, you can store the same kinds of data in the CALL channel as in the general purpose memories: just follow steps (1) through (3) of the memory storage procedure, and then press the CALL button instead of F/WRITE in step (4), while the "C" is blinking. Also, if storing a separate transmit frequency, press the CALL button instead of F/WRITE while holding the PTT switch (in the final step).

Scanning

Before starting the scanner, make sure the SQL control is set to squelch off the noise on a clear channel. Scanning is activated and deactivated by the UP or DWN keys on the microphone. Just press and hold the key for more than $\frac{1}{2}$ -second to start the scanner. If the transceiver is in the Dial mode, band scanning will result. If a memory number is displayed, the transceiver is in the Memory mode, and only the memories will be scanned.

The scanner pauses whenever a signal is detected which is strong enough to open the squelch, and the decimal point on the display blinks. You have a choice of two scan-resume modes: either Pause mode, in which the scanner pauses for as long as the carrier keeps the squelch open, or the 5-second duration mode, in which the scanner pauses for five seconds and then resumes scanning whether or not the signal is still present.

To set the scan-resume mode, press [F]+REV/STEP. A small "P" or "5" at the left indicates the current mode. Press F/WRITE to change it, or just press the REV/STEP button alone to return to the frequency display.

You can stop the scanner manually by pressing the PTT, UP or DWN key on the microphone, or the D/MR button.

Memory Skip Scanning

When you have some busy channels stored in memories you may wish to skip them when scanning other memories, but still have them available for manual selection. You can mark a memory to be skipped by pressing [F]+SKIP while the memory is recalled. "◀SKIP" will be displayed just to the right of the memory number box, and this memory will be skipped during scanning (although you can still recall it manually).

To unmask a scan-skip memory, just repeat the same steps you took to mask it: select the memory manually, and press [F]+SKIP.

Programmable Memory Scanning (PMS)

In addition to band and memory scanning, the FT-212RH can scan between two frequencies of your choice stored in the special memories labelled "L" and "U":

- (1) Store the lower edge of the desired scanning range in memory L, and the upper edge in memory U.
- (2) With either memory U or L recalled, press the MHz button. "M TUNE" will appear at the bottom center of the display.

You can now tune or scan as described previously, between the nearest multiples of 100 kHz (xxx.000, xxx.100, xxx.200, etc.) below memory L and above memory U.

To cancel PMS operation, stop scanning, if necessary (with the microphone keys or D/MR), and press D/MR: once to return to regular memory operation, or twice to return to Dial mode.

Priority Channel Monitoring

The Priority function allows automatic checking for activity on a memory every five seconds while operating on the Dial or other memories. When a signal appears on the priority memory while receiving, operation will automatically shift to that memory, for as long as a carrier is received. If you transmit while paused on the priority memory, priority monitoring is cancelled and operation stays on the priority memory.

The squelch must first be preset, and the frequency to be monitored must be stored in a memory (this **MUST** be memory 1 if you will be operating on other memories during priority monitoring).

Press D/MR to operate on the Dial, or else select the memory you want to operate on, and then press [F]+PRI. A 'P' will appear in the memory window at the upper left corner of the display, and about every five

seconds the displayed frequency will shift to the priority memory briefly while the receiver checks for a signal.

As long as no signal appears on the priority memory to open the squelch, you can tune, transmit and receive on the Dial, or select and operate on other memories. If a station you wish to talk with appears on the priority memory, press the PTT switch momentarily while receiving his signal, to stop priority checking. Otherwise, when a signal appears on the priority memory the scanner will pause and the decimal on the display will blink; then priority monitoring will resume (according to how you set the scan resume mode - either after a 5-second pause, or after the carrier drops). To cancel priority monitoring manually, press D/MR.

Note that you can use any other memory as a priority channel in the above procedure when operation is to be on the Dial.

Tone Squelch Operation

The FT-212RH includes a CTCSS encoder (for transmitting), and can also be used to silently monitor for calls on busy channels when the optional FTS-12 Tone Squelch Unit is installed. The encode function superimposes a subaudible tone (at a frequency too low to be heard) on the transmitted carrier, while the decode function (of the FTS-12) monitors receiver audio through a narrow filter at the same subaudible frequency, keeping the squelch closed until a matching tone is received. Installation instructions for the FTS-12 are in the 'Installation' chapter.

To check or set the CTCSS tone frequency, press [F]+TONE. The tone frequency will be displayed (in Hz), with a leading zero if that tone selection is a high-Q type. To change the tone frequency, rotate the selector knob or press the microphone DWN/UP keys until the display shows the tone frequency you require (the display will step through the standard EIA tones, plus 97.4 Hz). Press TONE to return to the operating frequency display when the tone frequency is selected.

To activate tone squelch press TONE. 'ENC' (encode) will be displayed and the tone generator will be activated for transmission. Press TONE again and both 'ENC' and 'DEC' (decode) will be displayed together as tone squelch is activated for both transmission and reception (only if

the FTS-12 is installed: a matching tone frequency will open the squelch). Pressing TONE once more disables tone squelch features.

Once you have the tone squelch set up the way you want it, you can store it in any memory. Afterwards, to change a memory, just recall it, reset the tone frequency or function, and store the memory again (press and hold F/WRITE $\frac{1}{2}$ -second, and then press it again momentarily).

DVS-1 DIGITAL VOICE SYSTEM

The DVS-1 is a combination of the latest microprocessor-controlled PCM (pulse-code modulation) digital voice recording and memory circuitry and digital DTMF decoder, allowing recording either from the microphone or of received signals, and playback through the loudspeaker or on the air.

A one-megabit RAM (random access memory) on the DVS-1 can be used as a single block for up to 128 seconds of recording, or divided into four or eight segments for selective recording and playback. Without the operator being present, incoming messages can be recorded by stations having access to the private station ID number and DTMF-equipped transceiver, and these messages can then be read back by the station operator, either locally or by remote access through DTMF control codes.

The sampling bit rate of the A-D (analog-to-digital) converter is front panel selectable between 8, 11, 16 and 32 kilobits/second, allowing the operator to select the optimum trade-off between recording time and fidelity. Different bit rates may be selected for different segments.

The programmable private station ID number (0001 to 9999) can be activated to restrict recording and playback, or recording only, of selected messages to only those stations previously notified of the ID number. The station owner can read received messages from a remote location using any DTMF-equipped transceiver.

The S-meter serves as an "elapsed time" indicator for recording and playback, and the microphone DWN and UP scanning keys serve to activate and deactivate recording and playback.

Voice System Display

When the DVS-1 is installed in the transceiver, it is toggled on and off by pressing the VOICE button. When the DVS-1 is on, the display shows the following format:

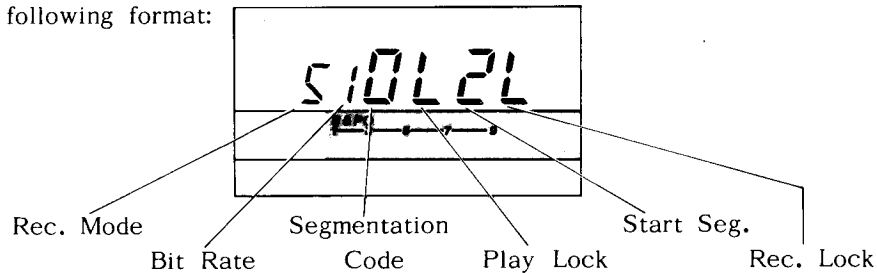

(1) Rec. (Recording) Mode ("S" or "M")

This is either "S" for Speaker or "M" for Microphone: the Speaker Recording Mode indicates that the source of audio for recording in this Segmentation Code is the loudspeaker - that is, received signals. The Microphone Recording Mode indicates that the source of audio for recording is the microphone - that is, messages from the local operator. The TONE button is used to toggle between these recording modes while the DVS-1 is activated.

(2) Bit Rate (1 - 4)

The number displayed in this location signifies the selected sampling bit rate for recording or playback in this Segmentation Code, as follows:

Bit Rate Code No.	Bit Rate (kbit/sec)	One Segment Record Time	Total Recording Time (all segs combined)
1	32	4 sec.	32 sec.
2	16	8 sec.	64 sec.
3	11	12 sec.	92 sec.
4	8	16 sec.	128 sec.

Note that the lower bit rates (larger Code Nos.) provide more recording time, but at reduced fidelity. While the DVS-1 is activated, pressing the REV button and rotating the tuning knob (while the

displayed Bit Rate is blinking) allows selection of the different rates.

(3) Segmentation Code (0 - 9 or A - F)

The character displayed here indicates both the segmentation method and segment selection of the 8-segment digital memory for recording and playback, as follows:

- 0 Segments 2 through 8 combined
- 1 Segment 1 (Callsign) only
- 2-8 Individual Segment access
- 9 Segments 1 and 2 combined
- A Segments 3 and 4 combined
- b Segments 5 and 6 combined
- C Segments 7 and 8 combined
- d Segments 2 and 4 combined
- E Segments 5 and 8 combined
- F Segments 2 - 8 accessed sequentially (one at a time)

While the DVS-1 is activated, rotating the tuning knob selects the Segmentation Code.

(4) Play Lock ("L" or blank)

"L" is displayed here when the Segmentation Code has been Locked to prohibit remote playback. These codes may still be played back locally, but cannot be recorded over or played back remotely. While the DVS-1 is activated, press the MHz button to toggle among Record Lock, no Lock, and both Playback and Record Lock (there is no Playback Lock only).

(5) Starting Segment (1 - 8)

The number here is the starting Segment number of this Segmentation Code for recording or playback. This is, of course, identical to the Segmentation Code for Codes 1 - 8, and is automatically selected when the Segmentation Code is chosen by the tuning knob.

(6) Rec. Lock ("L" or blank)

"L" is displayed here when the displayed Segmentation Code has been Locked to prohibit recording (BOTH local and remote). The description of Play Lock above describes how to select the Lock status. The record lock status can be changed remotely.

Segmentation Code Selection Notes

While the DVS-1 is activated, the tuning knob selects from among the sixteen possible Segmentation Codes. As indicated above, each Segmentation Code has its own set of associated parameters, displayed when each Code is selected.

Segmentation Code 1 is a special-purpose segment which should be recorded with your callsign. It is played back automatically in front of any of the other Codes when the DVS-1 is called remotely, for station id.

Note that Segmentation Codes 0, 9 and A - F select the same memory segments as Codes 1 - 8, merely with different partitioning. Therefore, if you record in Code 2, for example, the recording will be played back in Codes 0, 2, 9, d and F, since all of these access the same segment (2).

Recording

Most operators will probably want to partition the memory for two different purposes: storing your own replies to incoming calls, and recording incoming messages. You will have to determine how much of the memory to dedicate to each purpose yourself, which will, in turn, determine which memory segments to use for each purpose. However, regardless of that consideration, you should record your callsign in Segment 1, since this will be played back automatically in front of other DVS-1 responses to incoming calls.

Recording is turned on (and can be manually turned off) by the UP button on the microphone. While recording, the S-meter indicates the relative recording time elapsed: when the S-meter reaches full scale, the memory being recorded is full.

To record your callsign:

- (1) Turn on the radio, and press VOICE to activate the DVS-1.
- (2) Press the TONE button, if necessary, so that "M" is displayed at the left (to select Microphone recording).
- (3) Note the number (1 - 4) displayed just to the right of the "M", signifying the bit rate. You will want to experiment with all four possible bit rates (as detailed below), but for now, let's start with the fastest rate, number 1. If another number is displayed, press the REV button, turn to tuning knob until 1 is displayed next to the "M", and press REV again.
- (4) Rotate the tuning knob to select Segmentation Code 1 in the center of the display. Notice that a "1" also appears in the Starting Phrase display position (Code 1 always starts with Segment 1).
- (5) There should not be any "L"s on the display, since you don't want to lock out your callsign. If you see an "L" at the right, press the MHz button, repeatedly if necessary, to clear all "L"s.
- (6) Put your finger near the UP button on the microphone, and hold it near your mouth. Now watch the elapsed recording time indication on the S-meter, press the UP button and speak your callsign, then either press UP again to stop recording, or just wait until the S-meter reaches full scale (and recording stops automatically).

Unless you have a very short callsign, or spoke quickly, you probably didn't have time to fit it all in between the two beeps that signalled the start of recording and the beep at the end. Anyway, to check your results, just press the DWN button on the microphone (and adjust the volume, if necessary).

If you were very close, you might want to just press the UP button again and re-record, speaking a little faster. Otherwise (or just for fun), change the bit rate to 2 (press REV, turn the tuning knob one click clockwise, and press REV again) and try again. Notice you have twice the recording time (the S-meter advances more slowly during recording).

Press the DWN button again to play back this recording. You will notice it sounds a little 'scratchy'. Bit rates 3 and 4 provide even longer recording times, but sound even more scratchy (go ahead and try them). If you find you have a lot of left-over time (as indicated on the S-meter), press any microphone button to stop recording. Pick the fastest bit rate that gives you just the necessary recording time.

You can record any other memory segments in the same way you did your callsign. You may even record while transmitting (if the DVS-1 is activated), in which case Microphone recording is automatically selected.

On-The-Air Recording & Playback

When the DVS-1 is on, you can play back over the air anything that you have previously recorded: select the Code to play back and then press the DWN button while holding the PTT switch.

You can also record incoming signals heard in the loudspeaker:

- (1) Press VOICE (if displaying frequency) to activate the DVS-1.
- (2) Press TONE, if necessary, to select the Speaker recording mode.
- (3) Select the desired Segmentation Code using the tuning knob, and then select a Bit Rate using the REV button and tuning knob.
- (4) Press the UP button on the microphone to start recording.
- (5) Press the DWN button to play back the recording (and hold the PTT if you want to play it back over the air).

Remote Recording & Playback

If you have a second transceiver (any type, but with a DTMF keypad), you can operate the DVS-1 remotely using 3-key DTMF commands. To do this, the DVS-1 must first be activated and then set to the Remote Control Mode, as follows:

- (1) Press VOICE (if displaying frequency) to activate the DVS-1.

- (2) Note the indicated Bit Rate, and change it, if desired, by pressing the REV button, turning the tuning knob to select the desired Bit Rate, and pressing REV again.
- (3) Press the RPT button (the display will show simply "R" followed by the Bit Rate number (1 - 4).

The transceiver is now set for remote control. The Command Chart on the next page shows the various commands and their results. To send a command, hold the PTT switch on the remote transceiver while entering the indicated DTMF Code keys, one at a time. Then, if you are recording, speak into the microphone. Otherwise, release the PTT switch and listen for the response from the DVS-1. Note that Segment 1 (which should be your callsign) is read back before any other data is transmitted.

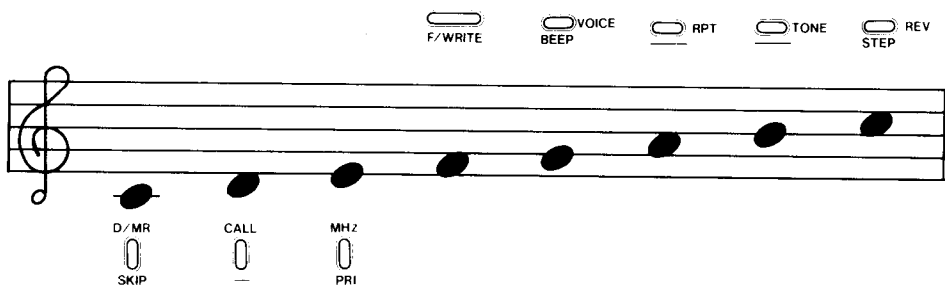

REMOTE COMMANDS

Func. Name	DTMF Code	Description	Note
Reset	###	Cancel input or stop recording	
Check Empty	#00	Check for unused segment(s)	(1)
Record All	*00	Record segments 2 through 8	(2)
Record One	*01	Record in any (unlocked) segment	(3)
Bit Rate	*1r	Set Bit Rate r (1 - 4) for recording	(2)
Confirm	#01	Playback last recording to confirm	(4)
Lock Last	*02	Lock last recording	(1)
Play All	#10	Playback all unlocked segments	(4)
Play One	#1x	Playback segment x (1 - 8 only)	(4)
UnLock All	#20	Unlock all locked segments	(1)
UnLock One	#2x	UnLock segment x (1 - 8 only)	(1)

Notes:

- (1) High/low tone response indicates success (memory available or lock/unlock executed), else low/high tone response indicates failure (memory full or lock/unlock not executed).
- (2) Callsign played back followed by a single beep if record successful, else low/high tones returned after callsign playback (to indicate record attempt failed).
- (3) Same as Note (2) if command accepted, else no response.
- (4) Callsign played back followed by a single beep and then the selected segment(s), if successful. Low/high tones if playback command rejected. In the case of multiple segments, each is separated by (suppressed) high/low beeps.

Whenever a remote command is received, the transceiver display shows the Segmentation Code accessed (0, or 2 - 8). Up to four Codes will be displayed, scrolling in from the right on a first-in/first-out basis (older Codes disappear). This allows you to tell at a glance if someone has called, and where their messages may be located.

Locking Segments

You may record some segments that you don't want played back over the air during remote access. These can be Locked out locally by pressing the MHz button when the DVS-1 is in its normal (non-remote) mode. Pressing MHz once locks out both recording and playback, indicated by an "L" near the center of the display and another "L" at the right side of the display. Press MHz a second time to allow playback, but not recording (only the rightmost "L" displayed). Press MHz a third time to cancel Lockout.

Note that segments that are locked out for playback cannot be accessed by remote operators. However, segments locked out for recording only (only rightmost "L" displayed when the Segmentation Code is displayed), can be unlocked by remote operators, and then recorded over and locked again, if desired. The usefulness of this design is that if you are away from the transceiver and have set it for remote operation, your friends can call in and leave messages. You can then access these messages while you are away, using another transceiver, and either leave your replies or just clear the available memories (those you haven't locked out for playback locally) to accept new messages.

Private Station ID Code

Obviously, the remote recording system just described could be a prankster's delight, so a special private station ID code is also programmable in the DVS-1 to prevent anyone from accessing the memories who does not know your ID code. Your ID code may be any number from 0001 to 9999. Once you have selected your ID, be careful who you divulge it to.

To set your ID code:

- (1) From the frequency display, press VOICE to activate the DVS-1, and then press F/WRITE followed by the RPT button. The display now shows the current ID code (or "0000" if none is stored), with the rightmost digit blinking.
- (2) Rotate the tuning knob to change the blinking digit.

- (3) Press the DWN button on the microphone to shift the blinking digit one place to the left.
- (4) Repeat steps 2 and 3 until the display shows the desired ID code number. Then press the RPT button again to return to the original DVS-1 display.

Once you have programmed your ID code, any station calling in with a remote command (when the DVS-1 is set for remote operation) must precede his DTMF command with the ID code you just stored. Leading zeros are not required, so, for example, if your ID code is 0001, remote commands need only be prefixed by a DTMF 1.

Any remote commands received without the ID code prefix will be ignored (unless you set the ID code to 0000).

Note: if the remote transceiver is very close to the DVS-1 it may be overloaded by the rf field, which may cause the DVS-1 to shut down (and return the display to the operating frequency) after responding to a remote command.

CAT System External Computer Control

The CAT (Computer Aided Transceiver) System in the FT-212RH allows external control of the operating frequency, transmit/receive switching, high/low transmit power selection and CTCSS tone frequency and encode/decode status from an external personal computer (CTCSS decoding requires that the optional FTS-12 CTCSS Unit be installed).

Serial data is passed from pin 2 or pin 3 (TxD) of the computer RS-232C serial port to pins 1 and 3 of the MIC jack on the front panel of the transceiver, wired as shown here:

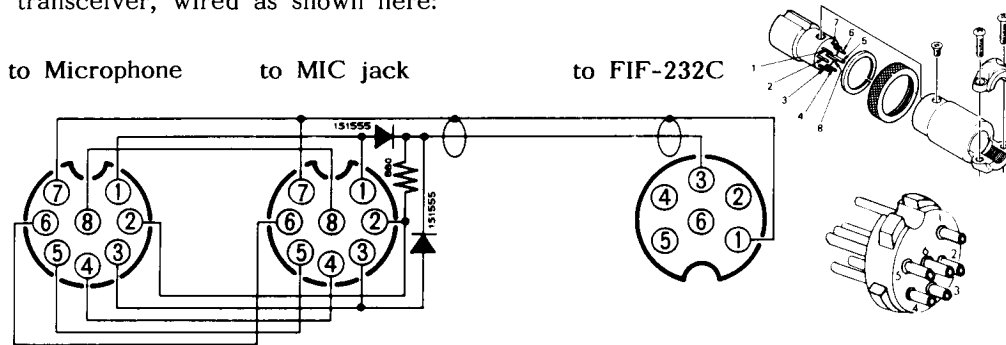

Data is sent at 4800 bits/sec., and each data byte sent consists of one start bit, 8 data bits, two stop bits and no parity bit:

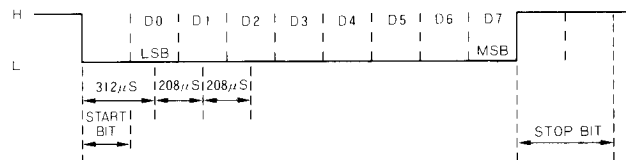

Data Format for 1 Character

All CAT System data transfers consist of blocks of five bytes as just described, sent with 50 to 200ms between each byte. The last byte to be sent in each block is the instruction opcode, while the first four bytes of each block are arguments: either parameters for that instruction, or dummy values (required to pad the block out to five bytes when fewer are needed by the instruction):

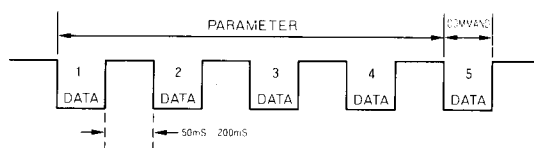

Data Format for 1 Block (5 Characters)

There are five types of instruction opcodes for the FT-212RH, listed in the Instruction Code Chart on the next page. Notice that three of the instructions require no arguments. However, every Command Block sent to the transceiver must always consist of five bytes. The unused parameter bytes will be ignored when such Instructions are executed, so their value is irrelevant (they need not be zeroed).

EXAMPLE: To set 145.5000 MHz as the current operating frequency;

- (1) Build the four argument byte values from the desired parameter (frequency, in this case):

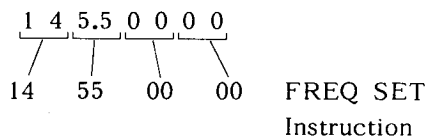

- (2) Convert the decimal frequency argument values into packed BCD (Binary-Coded-Decimal, with two decimal digits encoded into each byte), and add the appropriate instruction byte on the end. The small "h"s below indicate hexadecimal (base 16) values, which in packed BCD use the same digits as their decimal equivalents.

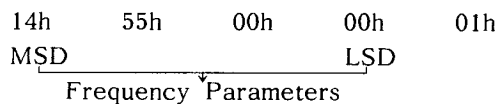

- (3) Send the five bytes to the transceiver, MSD first.

CTCSS TONE CODES

Freq. (Hz)	Value (Hex)	Freq. (Hz)	Value (Hex)	Freq. (Hz)	Value (Hex)
		136.5	2Fh	241.8	1Fh
67.0	3Eh	141.3	2Eh	250.3	1Eh
71.9	3Dh	146.2	2Dh	C67.0*	1Dh
77.0	3Ch	151.4	2Ch	C71.9	1Ch
82.5	3Bh	156.7	2Bh	C74.4	1Bh
88.5	3Ah	162.2	2Ah	C77.0	1Ah
94.8	39h	167.9	29h	C79.7	19h
100.0	38h	173.8	28h	C82.5	18h
103.5	37h	179.9	27h	C85.4	17h
107.2	36h	186.2	26h	C88.5	16h
110.9	35h	192.8	25h	C91.5	15h
114.8	34h	203.5	24h		
118.8	33h	210.7	23h	* 'C' tones are	
123.0	32h	218.1	22h	High Q (80)	
127.3	31h	225.7	21h		
131.8	30h	233.6	20h		

INSTRUCTION CODE CHART

("xx" indicates padding: any value is acceptable)

Instruction Name	Parameters (BCD)				Instr. Code	Remarks
	MSD					
CAT On/Off	xx	xx	xx	xx	yy	yy: 00h=ON, 80h=OFF. Must be ON before any other commands sent.
Frequency Set	p1	p2	p3	p4	01h	p1-p4: eight packed BCD digits*
Tx/Rx	xx	xx	xx	xx	yy	yy: 08h=Transmit, 88h=Receive
CTCSS Status	xx	xx	xx	xx	yy	yy: 0Ah=Enc/Dec, 4Ah=Enc, 8Ah=Off
CTCSS Tone Code	p1	xx	xx	xx	FAh	p1: see CTCSS Tone Chart above

* explained in text

In Case of Problems

FT-212RH operation is not complicated, but it is still possible to get lost, at least until you have had the chance to learn the various functions of the keypad and display. If the display shows nothing at all, check the power switch, and the power supply connections.

Fortunately, the display includes enough symbols and function indicators to let you know what is going on as long as power is applied, so it is well worthwhile to study the display diagram on page 6 carefully. For example, if the frequency display changes unexpectedly when you transmit (or if 'Err' appears), check for a small '+' or '-' near the upper right. Also, if only a few seemingly non-sensical digits appear, press TONE to disable the tone squelch setting feature. If nothing happens, press VOICE to disable the DVS-1 Digital Voice System (if it is installed).

If pressing a key appears to do nothing, first check for "LOCK" at the lower left, which indicates if the buttons are locked. If so, press [F]+LOCK to unlock the keys. Otherwise, if "LOCK" is not displayed, press D/MR, which will terminate any partially entered commands. If you still cannot enter data, check to see if "ON AIR" is displayed, indicating that the transceiver is transmitting. Releasing the PTT switch should return the set to receive. If still nothing happens, switch the transceiver off, and then back on.

To avoid confusion resulting from inadvertent key presses, set the keypad lock on (press [F]+LOCK) if you leave the transceiver unattended while it is on, and then remember to set the lock back off when you wish to enter data.

**MODIFICATION OF THE DVS-1
TO INHIBIT AUTOMATIC TRANSMISSION**

If your local laws prohibit automatic response transmissions of digital voice callsigns or messages during remote (unattended) operation, you can modify the DVS-1 so that it will not transmit during remote operation, as described below. Note that automatic recording during remote operation is not inhibited by this modification.



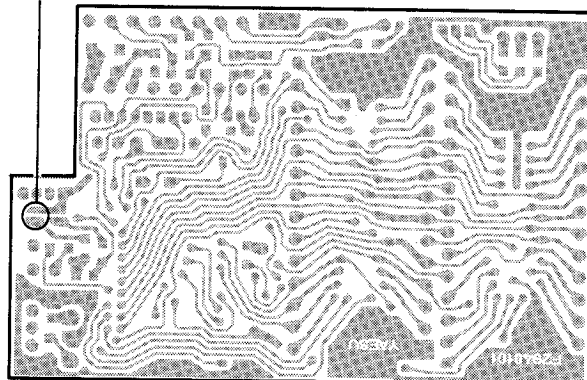







Bridge this split pad with solder



DVS-1 Solder Side

FT-212RH OPERATOR'S QUICK REFERENCE CHARTS

CHART 1. KEY FUNCTIONS

	Normal Function	Alternate Func (after )	Digital Voice Func.*
 0 DWR SEP	Toggle Dial/Memory modes	Scan Skip (Memory mode only)	see Normal Function
 0 CALL	Jump to CALL Channel	- none -	see Normal Function
 0 MHz PRI	Toggle MHz Tuning on/off	Toggle Priority monitoring	Record Lock Select
	Shift other keys to alternate functions	Cancel alternate key functions (automatic after 5 seconds)	F+RPT sets ID code, otherwise no func.
	Toggle DVS-1 Voice Unit	Toggle Beeper	Toggle DVS-1 ON/OFF
	Select Repeater Shift (plus - minus - off)	Display/Set Rptr Offset	Toggle Remote Mode, or set ID code (F+)
	Toggle Tone Squelch** (ENC - ENC/DEC - off)	Display/Set CTCSS Freq.	Toggle Speaker/Mic recording mode
	Reverse Repeater Split (only if RPT active)	Toggle Step Select (and use tuning knob)	Toggle Bit Rate Set (use knob to select)
	Toggle High/Low Power	Lock (or unlock) all keys (exc this one and F/WRITE)	Same as Norm/Alt Funcs

* Only if DVS-1 installed; otherwise inactive.

** Only if FTS-12 installed; otherwise inactive.

CHART 2. FUNCTIONAL REFERENCE

Note: Press $\overset{D/MR}{\underset{SKIP}{0}}$, if necessary, to select Dial Mode ("D" in the Chart) or Memory Mode ("M"), before entering other keystrokes. Memory Mode is active when a memory number is displayed in the box at the upper left.

symbols: "/" = or
 "[]" = optional
 "()" = intermediate display
 "⋮" = blinking display
 "+" = together (simultaneous)
 "F.WRITE" = hold at least ½-second

Desired Function	Dial/Mem	Keystroke(s)	Display
Beeper On/Off	D/M	$\overset{F.WRITE}{\text{F.WRITE}} \rightarrow \text{VOICE BEEP}$	
CALL Ch. Recall	D/M	$\overset{CALL}{\underset{---}{0}}$	\boxed{C}
Channel Step Select	D	$\overset{F.WRITE}{\text{F.WRITE}} \rightarrow \text{STEP REV} \rightarrow \text{DWN UP} \rightarrow \text{STEP REV}$	$P \quad 20$
Hide Memory	M	$\overset{F.WRITE}{\text{F.WRITE}} \rightarrow \text{STEP REV}$	\boxed{H}
Unhide Memory	M	$\overset{F.WRITE}{\text{F.WRITE}} \rightarrow \text{DWN UP} \rightarrow \text{STEP REV}$	\boxed{U}
Lock/Unlock Knob/Keys	D/M	$\overset{F.WRITE}{\text{F.WRITE}} \rightarrow \text{LOCK}$	\boxed{L}
Memory Recall	D	$\overset{D/MR}{\underset{SKIP}{0}} \rightarrow \text{DWN UP}$	\boxed{R}
Memory Tune	M	$\overset{MHz}{\underset{PRI}{0}} \rightarrow \text{DWN UP}$	$\boxed{M TUNE}$
Memory Storage	D	$\text{DWN UP} \rightarrow \overset{F.WRITE}{\text{F.WRITE}} (\boxed{R}) \rightarrow \text{DWN UP} \rightarrow \overset{F.WRITE}{\text{F.WRITE}}$	
Memo Separate Tx Freq.	D	$\text{DWN UP} \rightarrow \overset{F.WRITE}{\text{F.WRITE}} (\boxed{R}) \rightarrow \text{DWN UP} \rightarrow \text{1000} + \overset{F.WRITE}{\text{F.WRITE}} \rightarrow \text{+}$	
MHz Range	D	$\overset{MHz}{\underset{PRI}{0}} \rightarrow \text{DWN UP}$	$888.$
Priority Monitor (Dial)	D	$\overset{D/MR}{\underset{SKIP}{0}} (\boxed{R}) \rightarrow \text{DWN UP} \rightarrow \overset{D/MR}{\underset{SKIP}{0}} \rightarrow \overset{F.WRITE}{\text{F.WRITE}} \rightarrow \overset{MHz}{\underset{PRI}{0}}$	\boxed{P}
Priority Monitor (Mem)	M	$\overset{F.WRITE}{\text{F.WRITE}} \rightarrow \overset{MHz}{\underset{PRI}{0}}$	\boxed{P}
Repeater Standard Split	D/M	RPT	$\boxed{-} / \boxed{+}$
Repeater Split Offset	D/M	$\overset{F.WRITE}{\text{F.WRITE}} \rightarrow \text{RPT} \rightarrow \text{DWN UP} \rightarrow \text{RPT}$	8888
Reverse Tx/Rx Freqs.	D/M	STEP REV	\boxed{REV}
Scanning	D/M	DWN UP	
Scan Limited Subband	D	$\overset{D/MR}{\underset{SKIP}{0}} \rightarrow \text{DWN UP} (\boxed{U/L}) \rightarrow \overset{MHz}{\underset{PRI}{0}} (\boxed{M TUNE}) \rightarrow \text{DWN UP}$	
Scan Resume Mode	D	$\overset{F.WRITE}{\text{F.WRITE}} \rightarrow \text{STEP REV} \rightarrow \overset{F.WRITE}{\text{F.WRITE}} \rightarrow \text{STEP REV}$	P/S
Scan Skip Memory	M	$\text{DWN UP} \rightarrow \overset{F.WRITE}{\text{F.WRITE}} \rightarrow \overset{D/MR}{\underset{SKIP}{0}}$	$\boxed{4SKIP}$

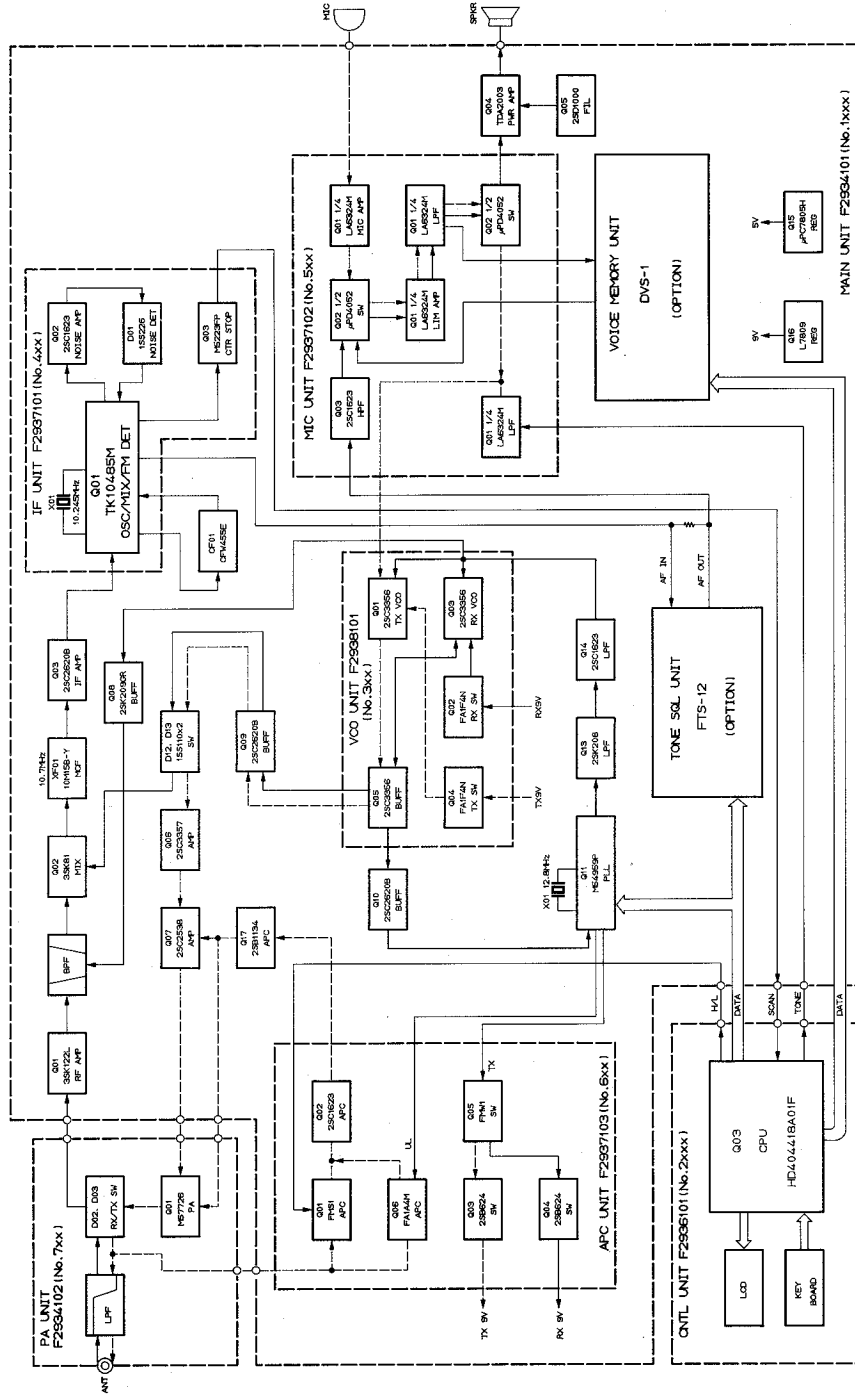

FT-212RH
BLOCK DIAGRAM

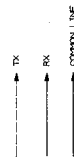

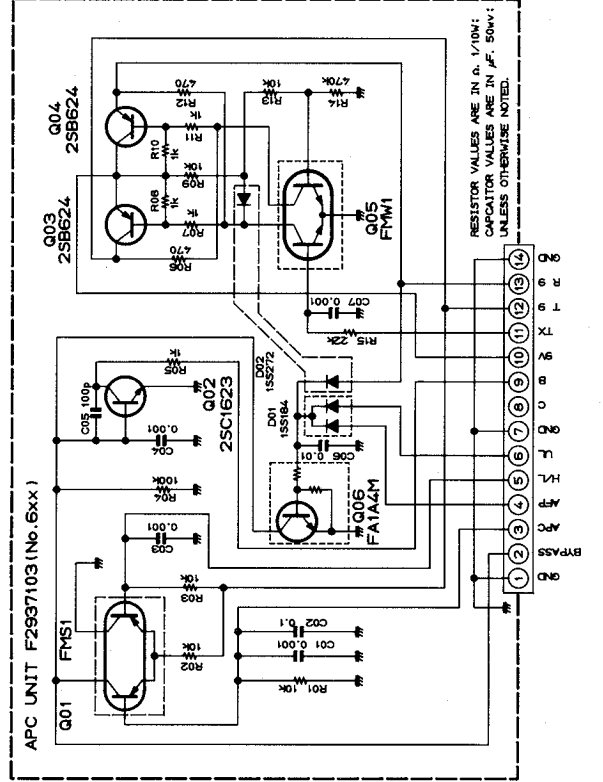
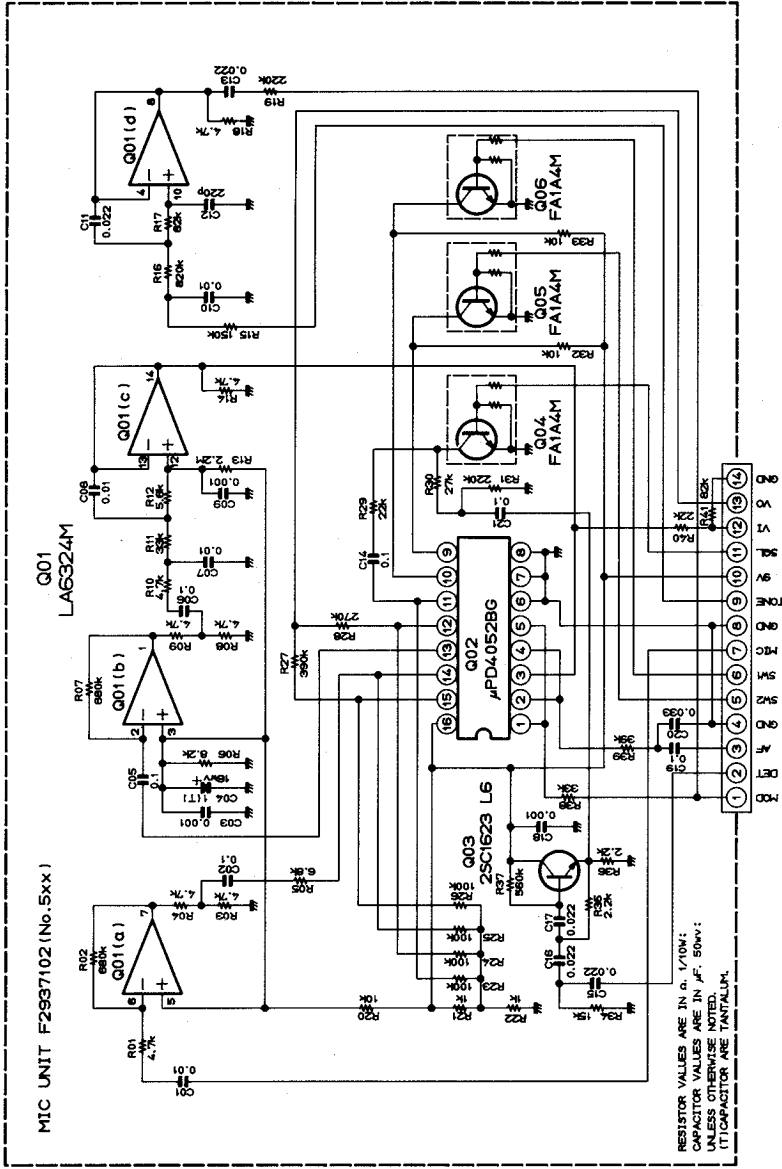
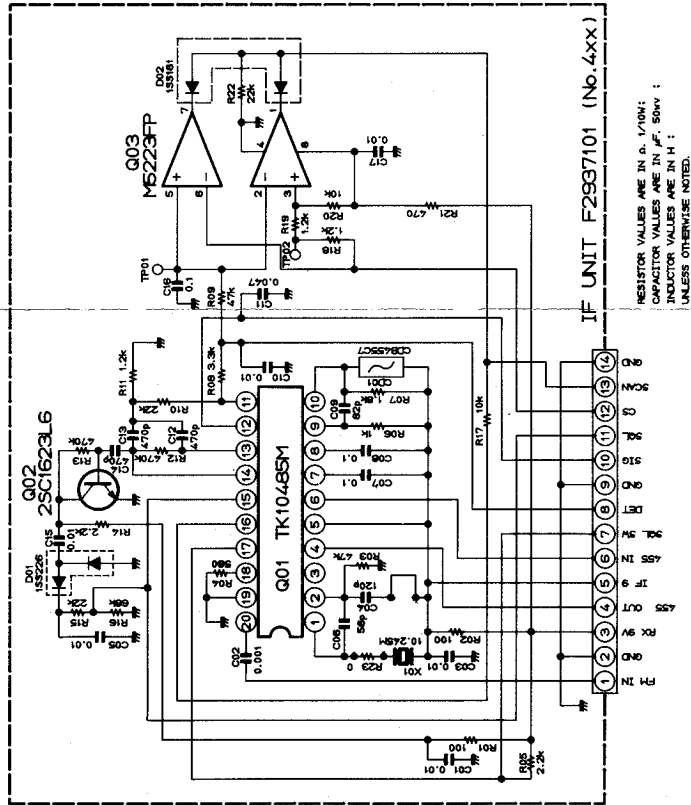
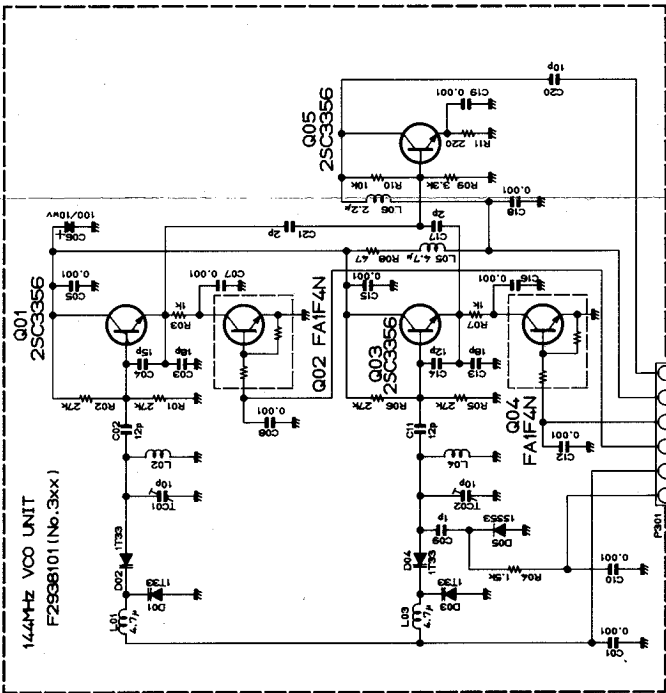

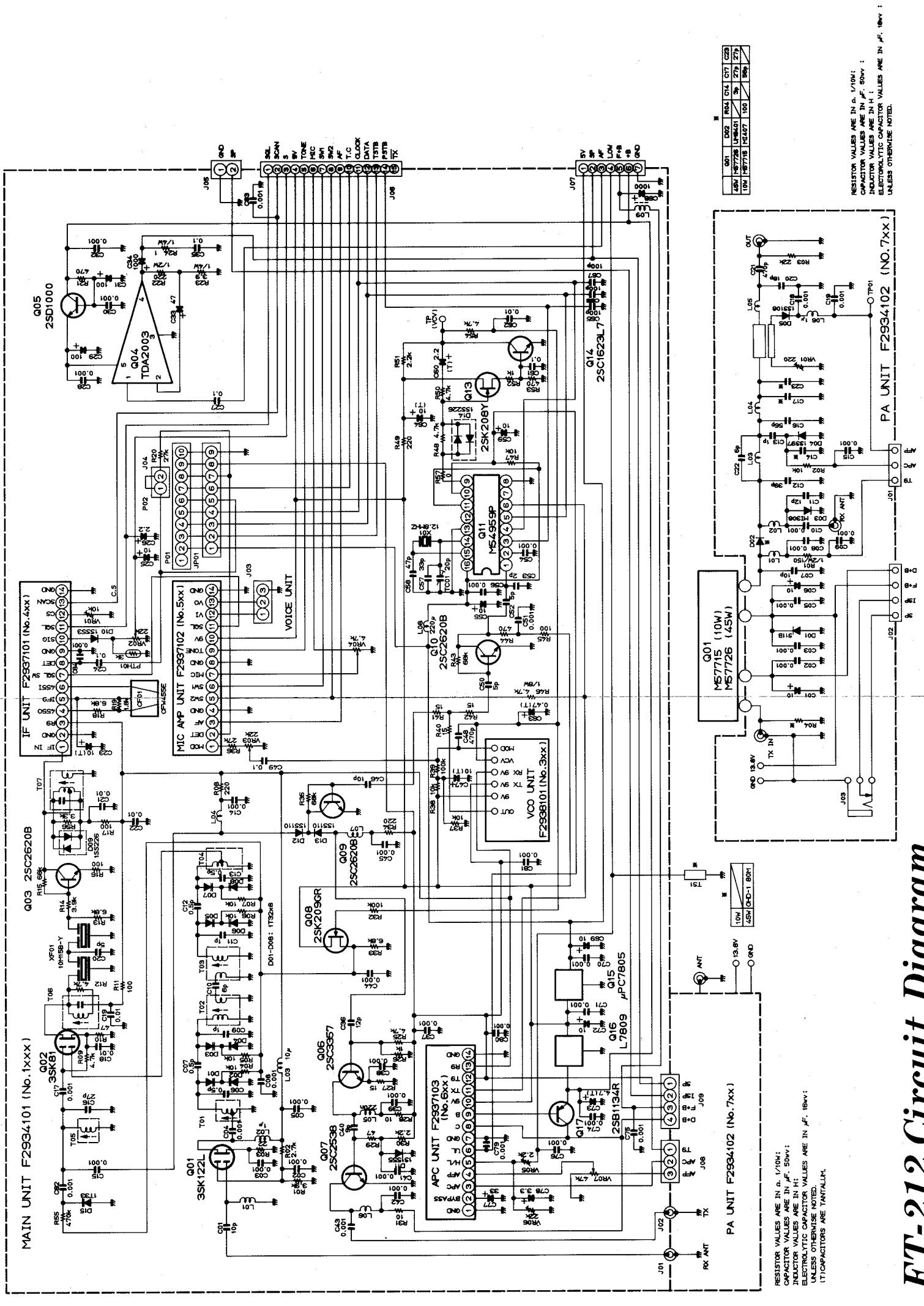

Q01	D02	R04	Q14	C17	C08
45N	1N4728	10K	2SC1623L	27P	27P
10M	1N4718	10K	2SC1623L	100	100

RESISTOR VALUES ARE IN Ω, 1/10Ω;
 CAPACITOR VALUES ARE IN μF, 50μV;
 INDUCTOR VALUES ARE IN H;
 ELECTROLYTIC CAPACITOR VALUES ARE IN μF, 100V;
 UNLESS OTHERWISE NOTED.

RESISTOR VALUES ARE IN Ω, 1/10Ω;
 CAPACITOR VALUES ARE IN μF, 50μV;
 INDUCTOR VALUES ARE IN H;
 ELECTROLYTIC CAPACITOR VALUES ARE IN μF, 100V;
 UNLESS OTHERWISE NOTED.
 (T) CAPACITORS ARE TANTALUM.

FT-212 Circuit Diagram

TONE SQUELCH FUNCTIONS (with FTS-12 option only)

" / " = or

Desired Function	Keystroke(s)	Display
Set CTCSS Tone Freq.	→ → / →	888.88
Toggle CTCSS ENC/DEC	/ →	/

DIGITAL VOICE FUNCTIONS (with DVS-1 option only)

Voice System On/Off		5 10 2
Bit Rate Selection	→ →	5 10 2
Select Mic/Spkr Input		S/M 10 2
Record Selected Input		
Playback		
Playback On Air	+	
Remote DTMF Control		R 1
Lock Out Recording	/ →	5 10 L 2 L
Lock Out Recording	/ →	5 10 2 L

YAESU



YAESU MUSEN CO., LTD.
C.P.O. BOX 1500
TOKYO, JAPAN



E2540100(901J-HW)

